



mis[®]
ВНУТРЕННИЙ ШЕСТИГРАННИК
ортопедические элементы

Узкая платформа (Ø3.30)

Ортопедические элементы - Узкая платформа



Fixed Prosthetic Options

Заглушка



MC1-00330

Формирователи



MH-N2330
MH-N3330
MH-N4330
MH-N5330
MH-N6330



MH-52330
MH-53330
MH-54330
MH-55330
MH-56330

Слепочные трансферы



MN-IT100



MN-IO330



MN-IT300



MN-IC600



MN-PF330

Аналог



MN-RSM10

Временные абатменты



MN-TPA10



MN-TPA12

Ортопедические элементы

Ортопедические винты

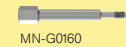

MN-G0160

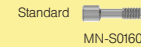

Standard

MN-S0160

Винтовая фиксация (выжигаемый пластик)



MN-CP013



MN-CPH13

Цементная фиксация



MN-MAC10



MN-CPK41 MN-CPK61
MN-CPK42 MN-CPK62
MN-CPK43 MN-CPK63
MN-CPK44 MN-CPK64



MN-IC040

выжигаемый колпачек
без антиротационного
компонентом



MN-ICH40

выжигаемый колпачек
с антиротационным
компонентом

Угловые абатменты - цементная фиксация









MN-AN020

Узкая платформа



Все супраструктуры
комплекуются винтами

Узкая платформа (Ø3.30)

Ортопедические элементы (Шаровидный абатмент, Locator)

	Шаровидный абатмент	Аналог	Пластиковая матрица	Матрица из сплава	Титановая матрица	Металлическая и пластиковые матрицы
Шаровидный абатмент	 <p>MB-N2330 MB-N3330 MB-N4330</p>	 <p>MB-RS375</p>	 <p>MB-SF200</p>	 <p>MB-GPS10</p>	 <p>MB-TTP10</p>	 <p>MB-DMH10 MB-PPR10 MB-PPC10</p>

	Locators - абатменты	Слепочный трансфер	Матрицы Locator	Аналог
Locators	 <p>MB-NZL00 MB-NZL01 MB-NZL02 MB-NZL03 MB-NZL04 MB-NZL05 MB-NZL06</p>	 <p>MM-LIC10</p>	 <p>MM-LMP02</p>	 <p>MM-LFA40</p>

	Ti Base	Аналог	Выдвигаемый колпачек
Ti Base	 <p>MN-TB001 MN-TB002</p>	 <p>MN-RSM10</p>	 <p>GI-NCH11</p>

Детализация имплантатов

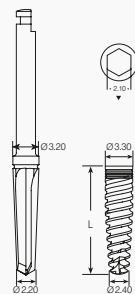

SEVEN® — 3.30 —
Диаметр

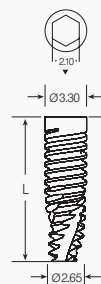

M4 — 3.30 —
Диаметр

Стандартная платформа (Ø3.75, Ø4.20)

Ортопедические элементы - Стандартная платформа



M4

MF4-08375
MF4-10375
MF4-11375
MF4-13375
MF4-16375



SEVEN

MF7-08375
MF7-10375
MF7-11375
MF7-13375
MF7-16375



M4

MF4-06420
MF4-08420
MF4-10420
MF4-11420
MF4-13420
MF4-16420



SEVEN

MF7-06420
MF7-08420
MF7-10420
MF7-11420
MF7-13420
MF7-16420

Fixed Prosthetic Options

Заглушка



MC1-00375

Формирователи



MH-03375
MH-04375
MH-05375
MH-06375



MH-53375
MH-54375
MH-55375
MH-56375

Слепочные трансферы



MD-IT100



MD-I0375



MD-IT300



MD-IC800



MD-PF375

Аналог



MD-RSM10

Временные абатменты



MD-TPH50



MD-TCH13



MD-TPA10



MD-TPA12

Ортопедические элементы

Ортопедические винты



Винт из сплава



Винтовая фиксация (выжигаемый пластик)



MD-CP013



MD-CPH13



MD-CP050



MD-CPH50

Винтовая фиксация (выжигаемый пластик на сплаве)



MD-GP010



MD-GPC10

пластиковые абатменты с основанием из сплава

Цементная фиксация



MD-A0010



MD-P0030



MD-CR010



MD-CTP10



MD-MAC10



MD-WMAC1



MD-MACF1



* MD-CPK41 MD-CPK61 MD-CPK81
MD-CPK42 MD-CPK62 MD-CPK82
MD-CPK43 MD-CPK63 MD-CPK83
MD-CPK44 MD-CPK64 MD-CPK84



MD-IC040

выжигаемый колпачек без антиротационного компонента



MD-ICH40

выжигаемый колпачек с антиротационным компонентом

Угловые абатменты - цементная фиксация



MD-A1510



MD-A2510



MD-AN151



MD-P1530



MD-AN251



MD-P2530



Все супраструктуры комплектуются винтами



Стандартная платформа (Ø3.75, Ø4.20)

Ортопедические элементы (Мульти-Юнит, Шаровидный абатмент, OT Equators, Locator)

	Формирователь	Абатменты	Угловые абатменты	Слепочные трансферы	Аналог	Временный цилиндр	Пластиковый цилиндр
Мульти-Юнит	 MH-00450	 MA-S1375 MA-S2375 MA-S3375 MA-S4375	 MA-ANH17 MA-ANH30	 MM-IO450 MM-IT450	 MA-RSM10	 MM-T0450 материал - титан  MM-S0330	 MM-CP045 MM-S0330 <i>выжигаемый пластик</i>

	Шаровидный абатмент	Угловой шаровидный абатмент	Аналог	Пластиковая матрица	Металлическая и пластиковые матрицы
Шаровидный абатмент	 MB-N1375 MB-N2375 MB-N3375 MB-N4375 MB-N5375	 MB-AN152 MB-AN252	 MB-RS375 Матрица из сплава  MB-GPS10	 MB-SF200 Титановая матрица  MB-TTP10	 MB-DMH10 MB-PPR10 MB-PPC10

	Locators
Locators	 MB-SZL00 MB-SZL01 MB-SZL02 MB-SZL03 MB-SZL04 MB-SZL05 MB-SZL06
	Слепочный трансфер  MM-LIC10

	Ti Base
Ti Base	 MD-TB001
	 MD-TB002

Детализация ИМПЛАНТАТОВ

Пластиковый цилиндр на сплаве

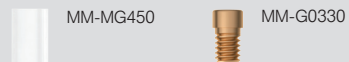

Основание из сплава



Locator матрицы



Аналог



Аналог Выжигаемый колпачек

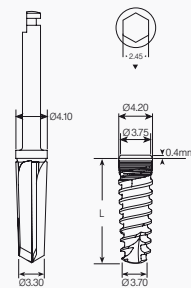
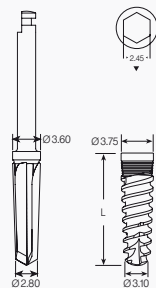

SEVEN® — 3.75 — Диаметр

4.20 — Диаметр

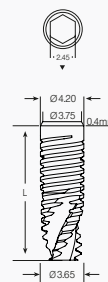
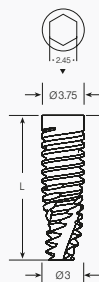

M4 — 3.75 — Диаметр

4.20 — Диаметр

Широкая платформа (Ø5, Ø6)

Ортопедические элементы - Широкая платформа



M4

MF4-06500
MF4-08500
MF4-10500
MF4-11500
MF4-13500
MF4-16500



SEVEN

MF7-06500
MF7-08500
MF7-10500
MF7-11500
MF7-13500
MF7-16500



M4

MF4-06600
MF4-08600
MF4-10600
MF4-11600
MF4-13600



SEVEN

MF7-06600
MF7-08600
MF7-10600
MF7-11600
MF7-13600

Fixed Prosthetic Options

Заглушка



MC1-00470

Формирователи



MH-W3500
MH-W4500
MH-W5500



MH-W3630
MH-W4630
MH-W5630

Слепочные трансферы



MW-IT100

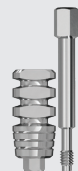

MW-I0470



MW-IT300



MW-IC800



MW-PF550

Аналог



MW-RSM10

Временные абатменты



MW-TPH50



MW-TPA10



MW-TPA12

Ортопедические элементы

Ортопедические винты

Standard



Винт из сплава



Винтовая фиксация (выжигаемый пластик)



MW-CP013



MW-CPH13



MW-CP060



MW-CPH60

Винтовая фиксация (выжигаемый пластик на сплаве)



MW-GP010



MW-GPC10

пластиковые
абатменты с
основанием из сплава

Абатменты - цементная фиксация



MW-CTP10



MW-MAC10



MW-WMAC1



MW-P0010



* MW-CPK41 MW-CPK61 MW-CPK81
MW-CPK42 MW-CPK62 MW-CPK82
MW-CPK43 MW-CPK63 MW-CPK83
MW-CPK44 MW-CPK64 MW-CPK84



MW-IC040

выжигаемый колпачек
без антиротационного
компонента



MW-ICH40

выжигаемый колпачек
с антиротационным
компонентом

Угловые абатменты - цементная фиксация



MW-P1510

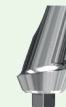







MW-AN151









Все супраструктуры
комплекуются винтами



Широкая платформа



Широкая платформа (Ø5, Ø6)

Ортопедические элементы (Мульти-Юнит, Шаровидный абатмент, OT Equators, Locator)

	Формирователь	Абатменты	Слепочные трансферы	Аналог	Временный цилиндр	Пластиковый цилиндр
Мульти-Юнит	 <p>MH-00450</p>	 <p>MA-W1500 MA-W2500 MA-W3500 MA-W4500</p>	 <p>MM-IO450 MM-IT450</p>	 <p>MA-RSM10</p>	 <p>MM-T0450</p> <p>материал - титан</p>  <p>MM-S0330</p>	 <p>MM-CP045</p> <p>выжигаемый пластик</p>  <p>MM-S0330</p>

	Шаровидный абатмент	Аналог	Пластиковая матрица	Титановая матрица	Металлическая и пластиковые матрицы
Шаровидный абатмент	 <p>MW-B1500 MW-B3500 MW-B5500</p>	 <p>MB-RS375</p>	 <p>MB-SF200</p>	 <p>MB-TTP10</p>	 <p>MB-DMH10</p>
			<p>Матрица из сплава</p>  <p>MB-GPS10</p>	 <p>MB-PPR10</p>	 <p>MB-PPC10</p>

	Locators
Locators	 <p>MB-WZL00 MB-WZL01 MB-WZL02 MB-WZL03 MB-WZL04 MB-WZL05 MB-WZL06</p>
	<p>Слепочный трансфер</p>  <p>MM-LIC10</p>

	Ti Base
Ti Base	 <p>MW-TB001</p>
	 <p>MW-TB002</p>

Детализация имплантатов

Пластиковый цилиндр на сплаве

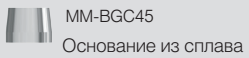
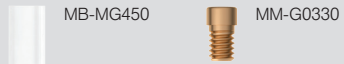

MM-BGC45

Основание из сплава

Locator матрицы



MM-LMP02

Аналог



MM-LFA50

Аналог

Выжигаемый колпачек



MW-RSM10



GI-WCH11

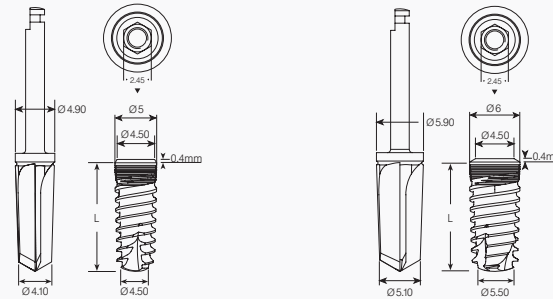

SEVEN® — 5.0 Диаметр — 6.0 Диаметр

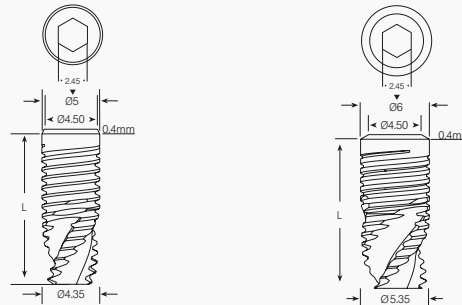

M4 — 5.0 Диаметр — 6.0 Диаметр

Широкая платформа

